



The World Depends on Sensors and Controls

YS10 Small Thermostat Protector

- High current capacity (125Vac/16A) to cut off power circuit.
- Keep small size as conventional protector MA10, and thermal sensitivity.
- Reliable long life

Features

YS10 was developed to protect people and property from accidents occurring on products such as Hair Dryer/Fan heater. It is an automatic resettable, incorporated thermal cut-out (Type 2C).

The YS10 pursued to enable to be used for higher wattage products, therefore highest current can be loaded through YS10, and directly cut off power line. But the distance of mounting holes is kept at same size as conventional protector MA10.

Construction

YS10 is constructed with only few parts as a simple and open design (IP00) and based on the well known thermostat technology of Texas Instruments.

1.Upper Terminal carries current to 2.Lower Terminal which is insert molded in 3.Lower Block, via 4.Movable Arm, 5.Movable Contact and 6.Stationary Contact. All parts are riveted to hold with 8.Eyelet. Refer drawing

7.Bimetal Disc is placing under 4.Movable Arm to push it up to open Contact, when 7.Bimetal Disc sensed high ambient temperature around YS10. Heat generated by 4.Movable Arm is designed properly on a combination with operation temperature and Trip current. Therefore, user could select best choice of MUST HOLD current for their product.

The YS10 is mounted by various means in conjunction with (holes in) the terminals, such that adequate creepage and clearance distances are maintained between live parts and accessible metal parts.

The electrical connections are for internal wiring only and are achieved by e.g. riveting, soldering or spot welding.

Specification

Contact Capacity:	12(3)A 250Vac, 16(3)A 125Vac,
Temperature Range:	60 to 150°C
Tolerance on Open Temperature:	+/- 5K
Max. Temp. of switch head:	150°C
Operating time:	continuous
Pollution situation:	normal
Extent of sensing element:	whole control

Certifications

UL	E 34618
CSA	24458
ENEC	2014531 / 17
CQC	CQC02002001338
MITI	JET99P No.0229

Dimension

Width 5.6 x Length 31.5 x Height 3.5mm
Distance between each hole : 26.5mm
Hole Diameter : 2.7mm

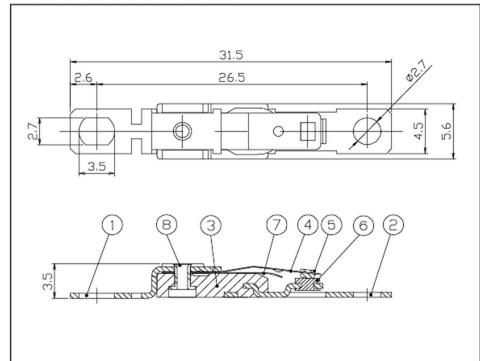

Performance

Ultimate Trip Current Curve :

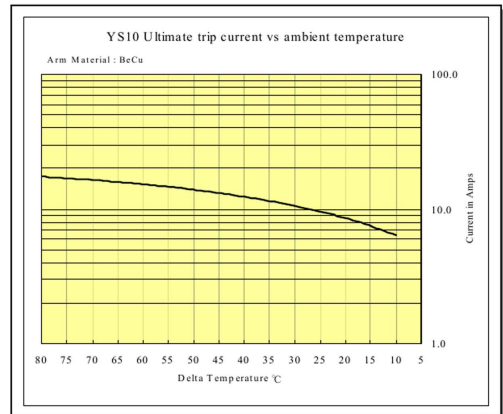

KLIXON
®

Sensata Technologies 082106-16



Small Thermostat Protector Numbering System

It is clearly defined the numbering system to find what user needs to know as follows.

YS10 XXY – T (ZZ)

ZZ: Differential for Reset Temperature from Operation Temp.
Blank for standard 30°C differential

T : Termination Identification
S : Standard Terminals (Length 31.5)
A : Both Terminals straight (Length 33.6)
T : PPS Insulator (Length 31.5)
 * Standard insulation is applied Vyloglass.

XX : Temperature Code Matrix

Standard Operating Temperature(°C)			
Operating Temperature	Temperature Code	Operating Temperature	Temperature Code
60°C	56	110°C	36
65°C	96	115°C	41
70°C	71	120°C	01
75°C	51	125°C	81
80°C	91	130°C	11
85°C	61	135°C	06
90°C	21	140°C	66
95°C	31	145°C	76
100°C	26	150°C	46
105°C	16		

Y : Movable Arm Identification

A : Titanium Copper **C :** Nickel Copper
B : Beryllium Copper **D :** Stainless Steel
 Note : BeCu is only certified material for ENEC.

YS10 : Device Identification

Terminal Identification

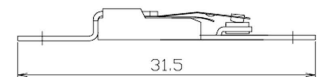
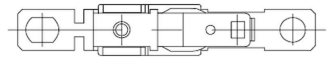

Type S (Standard Configuration)

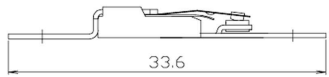
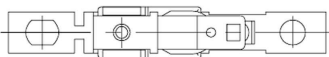

Type A

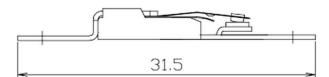
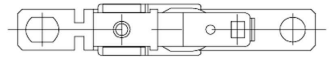

Type T

Ex. YS10 01B-S

120°C operation temperature, BeCu Movable Arm, Standard Terminals and 30°C differential. (90°C reset)